

Yealink

Prime Business Phone

SIP-T54W

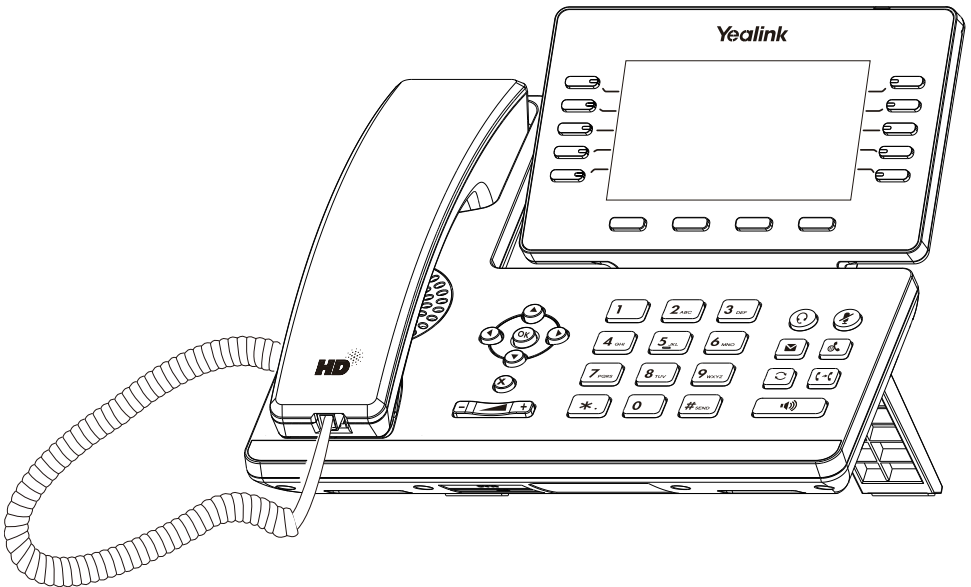

Quick Start Guide (V86.46)

Package Contents

The following items are included in your package. If you find anything missing, contact your system administrator.

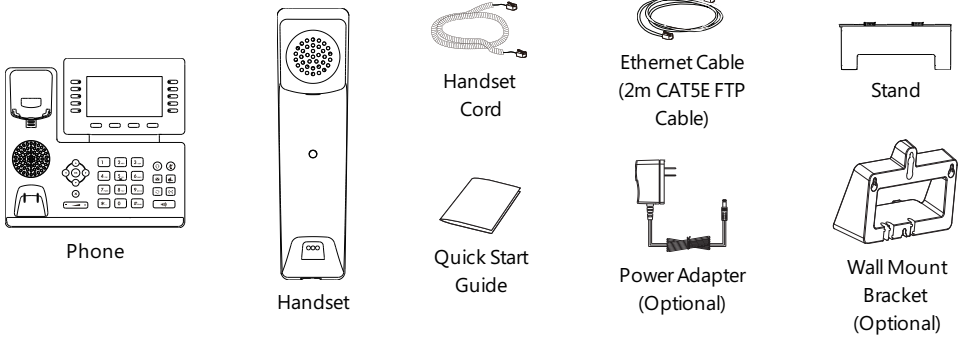

Note: We recommend that you use the accessories provided or approved by Yealink. The use of unapproved third-party accessories may result in poor performance.

Assembling Your Phone

1. Attach the stand and adjust the angle of the screen

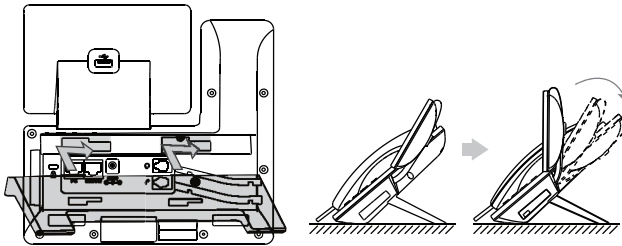

Note: You can also mount the phone to a wall.

2. Connect the handset and optional headset

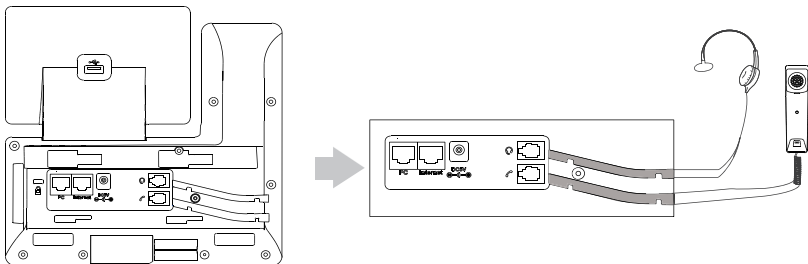

3. Optional: Connect the USB devices

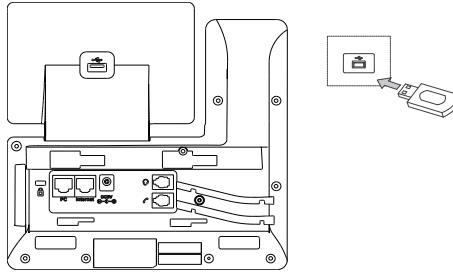

Note: The USB port can also be used to connect other USB devices, such as EXP50, USB headset and so on.

4. Connect the network and power

You have two options for network and power connections. Your system administrator will advise you which one to use.

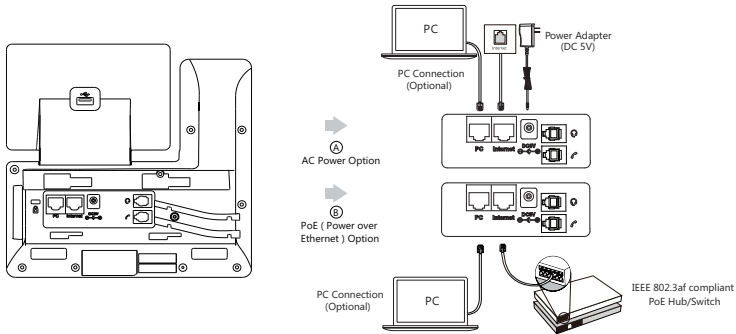

Note: The IP phone should be used with Yealink original power adapter (5V/2A) only. The use of the third-party power adapter may cause the damage to the phone. If you are connecting a PC to your phone, we recommend that you use the Ethernet cable provided by Yealink. If in line power (PoE) is provided, you don't need to connect the power adapter. Make sure the hub/switch is PoE-compliant.

Starting the Phone

After the phone is connected to the network and supplied with power, it automatically begins the initialization process. After startup, the phone is ready for use. You can configure the phone via phone user interface or web user interface.

Welcome
Initializing... Please wait

Configuring Your Phone

Configuring via web user interface

Accessing the web user interface:

1. Press **OK** to obtain the IP address of the phone.
2. Open a web browser on your computer, enter the IP address into the address bar (for example, "http://192.168.0.10" or "192.168.0.10").
3. In the Login page, type the user name (default: admin) and password (default: admin) and click **Login**.

Configuring Network Settings: Click **Network->Basic->IPv4 Config**

DHCP: By default, the phone attempts to contact a DHCP server in your network to obtain its valid network settings, for example, IP address, subnet mask, gateway address and DNS address.

Static IP: If your phone cannot contact a DHCP server for any reason, you need to configure them manually.

Note: The phone also supports IPv6, but IPv6 is disabled by default. Wrong network settings may result in the inaccessibility of your phone and may have an impact on the network performance. Contact your system administrator for more information.

Configuring Account Settings: Click **Account->Register->Account X (X=1, 2, 3...15, 16)**

Parameters of the account:

Register Status:	It shows the register status of the current account.
Line Active:	It enables or disables the account.
Label:	It is shown on the LCD screen to identify the account.
Display Name:	It is shown as caller ID when placing a call.
User Name:	It is provided by ITSP (required).
Register Name:	It is provided by ITSP (required).
Password:	It is provided by ITSP (required).
Server Host:	It is provided by ITSP (required).

Register status icons on the LCD screen:



Note: Check with your system administrator if any error appears during the registration process or a specific configuration is required for your registration.

Configuring via phone user interface

Configuring Network Settings:

Navigate to **Menu->Advanced** (default password: admin)->**Network->WAN Port->IPv4**.

Configuring Account Settings:

Navigate to **Menu->Advanced** (default password: admin)->**Accounts**.

Note: For more information on account parameters, refer to **Configuring via web user interface** above.

Using Basic Call Functions

Placing a Call

Using the handset:

1. Pick up the handset.
2. Enter the number, and then press **Send**.

Using the speakerphone:

1. With the handset on-hook, press .
2. Enter the number, and then press **Send**.

Using the headset:

1. With the headset connected, press  to activate the headset mode.
2. Enter the number, and then press **Send**.

Note: During a call, you can alternate between the headset, hands-free speakerphone and handset modes by pressing the **HEADSET** key, the **Speakerphone** key or by picking up the handset. Headset mode requires a connected headset.

Answering a Call

Using the handset:

Pick up the handset.

Using the speakerphone:

Press .

Using the headset:

Press .

Note: You can reject an incoming call by pressing **Reject**.

Ending a Call

Using the handset:

Hang up the handset or press **End Call**.





Using the speakerphone:

Press  or **End Call**.



Using the headset:

Press **End Call**.

Redialing a Call

- Press  to enter the **Placed Calls** list, press  or  to select the desired entry, and then press  or **Send**.
- Press  twice when the phone is idle to dial out the last dialed number.

Muting and Un-muting a Call





- Press  to mute the microphone during a call.
- Press  again to un-mute the call.

Holding and Resuming a Call

To Hold a call:

Press  or **Hold** during an active call.



To Resume the call, do one of the following:

- If there is only one call on hold, press  or **Resume**.
- If there is more than one call on hold, press  or  to select the desired call, and then press  or **Resume**.



Transferring a Call

You can transfer a call in the following ways:



Performing a Blind Transfer

1. Press  or **Transfer** during an active call. The call is placed on hold.
2. Enter the number you want to transfer to.
3. Press  or **B Transfer**.

Performing a Semi-Attended Transfer

1. Press  or **Transfer** during an active call. The call is placed on hold.
2. Enter the number you want to transfer to, and then press **Send**.
3. Press  or **Transfer** when you hear the ring-back tone.

Performing a Attended Transfer

1. Press  or **Transfer** during an active call. The call is placed on hold.
2. Enter the number you want to transfer to, and then press **Send**.
3. Press  or **Transfer** when the second party answers.

Forwarding a Call



To enable call forward:

1. Navigate to **Menu->Features->Call Forward**.
2. Select the desired forward type:

Always Forward----Incoming calls are forwarded unconditionally.

Busy Forward----Incoming calls are forwarded when the phone is busy.

No Answer Forward----Incoming calls are forwarded if not answered after a period of time.

3. Enter the number you want to forward to. For **No Answer Forward**, press  or  to select the desired ring time to wait before forwarding from the **After Ring Time** field.
4. Press **Save** to accept the change.

Initiating a Conference Call

1. Press **Conference** during an active call. The call is placed on hold.
2. Enter the number of the second party, and then press **Send**.
3. Press **Conference** again when the second party answers. Three parties are now joined in the conference.

Note: You can split the conference call into two individual calls by pressing **Split**.

Configuring and Using Speed Dial

To configure a speed dial key:

1. Navigate to **Menu->Features->Dsskey**.
2. Select the desired DSS key, and then press **Enter**.
3. Select **SpeedDial** from the **Type** field, select the desired line from the **Account ID** field, enter a label in the **Label** field and then enter the number in the **Value** field.
4. Press **Save** to accept the change.

To use the speed dial key:

Press the speed dial key to dial out the preset number.

Listening to Voice Mails



Message waiting indicator on the idle screen indicates that one or more voicemail messages are waiting at the message center. The power indicator LED slowly flashes red.

To listen to voice mails:

1. Press  or **Connect**.
2. Follow the voice prompts to listen to your voicemail messages.

Customizing Your Phone

Managing Call History



1. Press **History**.
2. Press  or  to select an entry from the list.
3. Do the following:
 - Press **Send** to call the entry.
 - Press **Delete** to delete the entry from the list.
 - Press **Option**, you can do the following:
 - Select **Detail** to view detailed information about the entry.
 - Select **Add to Contacts** to add the entry to the local directory.
 - Select **Add to Blacklist** to add the entry to the blacklist.
 - Select **Delete All** to delete all entries from the list.

Managing Contact Directory



Adding a contact:

1. Press **Directory**, and then select **All Contacts**.
2. Press **Add** to add a contact.
3. Enter a unique contact name in the **Name** field and contact numbers in the corresponding fields.
4. Press **Save** to accept the change.

Editing a contact:

1. Press **Directory**, and then select **All Contacts**.
2. Press  or  to select the desired contact, press **Option** and then select **Detail** from the prompt list.
3. Edit the contact information.
4. Press **Save** to accept the change.





Deleting a contact:

1. Press **Directory**, and then select **All Contacts**.
2. Press  or  to select the desired contact, press **Option** and then select **Delete** from the prompt list.
3. Press **OK** when the LCD screen prompts "Delete selected item?".

Adjusting the Volume

Press  to adjust the volume.

Setting Ring Tones

1. Navigate to **Menu->Basic->Sound->Ring Tones**.
2. Press  or  to select **Common** or the desired account and then press **Enter**.
3. Press  or  to select the desired ring tone.
4. Press **Save** to accept the change.

Regulatory Notices

Operating Ambient Temperatures

- Operating temperature: +32 to 104°F (0 to 40°C)
- Relative humidity: 5% to 90%, noncondensing
- Storage temperature: -22 to +160°F (-30 to +70°C)

Warranty

Our product warranty is limited only to the unit itself, when used normally in accordance with the operating instructions and the system environment. We are not liable for damage or loss resulting from the use of this product, or for any claim from a third party. We are not liable for problems with Yealink device arising from the use of this product; we are not liable for financial damages, lost profits, claims from third parties, etc., arising from the use of this product.

Explanation of the symbols

DC symbol

--- is the DC voltage symbol.

WEEE Warning symbol



■ To avoid the potential effects on the environment and human health as a result of the presence of hazardous substances in electrical and electronic equipment, end-users of electrical and electronic equipment should understand the meaning of the crossed-out wheeled bin symbol. Do not dispose of WEEE as unsorted municipal waste and have to collect such WEEE separately.

Restriction of Hazardous Substances Directive (RoHS)

This device complies with the requirements of the EU RoHS Directive. Statements of compliance can be obtained by contacting support@yealink.com.

Safety Instructions

Save these instructions. Read these safety instructions before use!

⚠ General Requirements

* Before you install and use the device, read the safety instructions carefully and observe the situation during operation.

* During the process of storage, transportation, and operation, please always keep the device dry and clean, avoid collision and crash.

* Please attempt not to dismantle the device by yourself. In case of any discrepancy, please contact the appointed maintenance center for repair.

* Please refer to the relevant laws and statutes while using the device. Legal rights of others should be respected as well.

⚠ Environmental Requirements

* Do not cover ventilation openings, this equipment is not intended to be used on soft support.

* The marking information is located at the exterior of the bottom.

* Place the device at a well-ventilated place. Do not expose the device under direct sunlight.

* Keep the device dry and free of dusts.

* Do not place the device on or near any inflammable or fire-vulnerable object, such as rubber-made materials.

* Keep the device away from any heat source or bare fire, such as a candle or an electric heater.

⚠ Operating Requirements

* Do not let a child operate the device without guidance.

* Do not let a child play with the device or any accessory in case of accidental swallowing.

* Please use the accessories provided or authorized by the manufacturer only.

* The power supply of the device shall meet the requirements of the input voltage of the device.

Please use the provided surge protection power socket only.

* Before plugging or unplugging any cable, make sure that your hands are completely dry.

* Do not spill liquid of any kind on the product or use the equipment near water, for example, near a bathtub, washbowl, kitchen sink, wet basement or near a swimming pool.

* During a thunderstorm, stop using the device and disconnect it from the power supply.

Unplug the power plug and the Asymmetric Digital Subscriber Line (ADSL) twisted pair (the radio frequency cable) to avoid lightning strike.

* If the device is left unused for a rather long time, disconnect it from the power supply and unplug the power plug.

* When there is smoke emitted from the device, or some abnormal noise or smell, disconnect the device from the power supply, and unplug the power plug immediately.

* Contact the specified maintenance center for repair.

* Do not insert any object into equipment slots that is not part of the product or auxiliary product.

* Before connecting a cable, connect the grounding cable of the device first. Do not disconnect the grounding cable until you disconnect all other cables.

⚠ Cleaning Requirements

* Before cleaning the device, disconnect it from the power supply.

* Use a piece of soft, dry and anti-static cloth to clean the device.

* Keep the power plug clean and dry.

Troubleshooting

The unit cannot supply power to Yealink device.

There is a bad connection with the plug.

1. Clean the plug with a dry cloth.

2. Connect it to another wall outlet.

The usage environment is out of operating temperature range.

1. Use in the operating temperature range.

The cable between the unit and the Yealink device is connected incorrectly.

1. Connect the cable correctly.

You cannot connect the cable properly.

1. You may have connected a wrong Yealink device.

2. Use the correct power supply.

Some dust, etc., may be in the port.

1. Clean the port.

Contact your dealer or authorized service facility for any further questions.

FCC Statement

This device complies with part 15 of the FCC Rules. Operation is subject to the following

two conditions: (1) this device may not cause harmful interference, and (2) this device must accept any interference received, including interference that may cause undesired operation.

Any Changes or modifications not expressly approved by the party responsible for compliance could void the user's authority to operate the equipment.

IC Statement

This device complies with Industry Canada's licence-exempt RSSs. Operation is subject to the following two conditions:

(1) this device may not cause interference; and

(2) this device must accept any interference, including interference that may cause undesired operation of the device. CAN ICES-3(B)

Le présent appareil est conforme aux CNR d'Industrie Canada applicables aux appareils radio exempts de licence. L'exploitation est autorisée aux deux conditions suivantes :

(1) l'appareil ne doit pas produire de brouillage;

(2) l'utilisateur de l'appareil doit accepter tout brouillage radioélectrique subi, même si le brouillage est susceptible d'en compromettre le fonctionnement. NMB-3(B)

2. This device meets CS03 Part V.

* This device meets the applicable Innovation, Science and Economic Development Canada technical specifications. / Ce produit répond à la innovation, des sciences et de Développement économique Canada spécifications techniques applicables. *

Radiation Exposure Statement

This device complies with FCC and IC radiation exposure limits set forth for an uncontrolled environment. This equipment should be installed and operated with minimum distance 20cm between the radiator and your body.

This device contains the limited wireless module YL1023 which built-in 2.4GHz and 5GHz WiFi and 2.4GHz Bluetooth. The limited wireless module YL1023 has its own FCC ID T2C-YL1023 and IC ID 10741A-YL1023.

Cet émetteur ne doit pas être Co-placé ou ne fonctionnant en même temps qu'aucune autre antenne ou émetteur. Cet équipement devrait être installé et actionné avec une distance minimum de 20 centimètres entre le radiateur et votre corps.

Contact Information

YEALINK NETWORK TECHNOLOGY CO., LTD.

309, 3rd Floor, No. 16, YunDing North Road, Hulü District, Xiamen City, Fujian, P. R. C

YEALINK (EUROPE) NETWORK TECHNOLOGY B. V.

Strawinskylaan 3127, Atrium Building, 8th floor, 1077XZ Amsterdam, The Netherlands

YEALINK (USA) NETWORK TECHNOLOGY CO., LTD.

999 Peachtree Street Suite 2300, Fulton, Atlanta, GA, 30309, USA

Made in China

Technical Support

Visit Yealink WIKI (<http://support.yealink.com/>) for the latest firmware, guides, FAQ, Product documents, and more. For better service, we sincerely recommend you to use Yealink Ticketing system (<https://ticket.yealink.com>) to submit all your technical issues.

Web: www.yealink.com Copyright©2021 YEALINK(XIAMEN)

NETWORK TECHNOLOGY CO.,LTD. All rights reserved



430104001846

